

N-CHANNEL ENHANCEMENT MODE MOSFET
Product Summary

$V_{(BR)DSS}$	$R_{DS(ON)}$	Package	I_D $T_C = 25^\circ C$
650V	$3.0 \Omega @ V_{GS} = 10V$	ITO220-3	4.0 A

Description

This new generation complementary MOSFET features low on-resistance and fast switching, making it ideal for high efficiency power management applications.

Applications

- Motor control
- Backlighting
- DC-DC Converters
- Power management functions

Features

- Low Input Capacitance
- High BVD_{SS} rating for power application
- Low Input/Output Leakage
- **Lead-Free Finish; RoHS Compliant (Notes 1 & 2)**
- **Halogen and Antimony Free. "Green" Device (Note 3)**
- **Qualified to AEC-Q101 Standards for High Reliability**

Mechanical Data

- Case: ITO220-AB
- Case Material: Molded Plastic, "Green" Molding Compound. UL Flammability Classification Rating 94V-0
- Moisture Sensitivity: Level 1 per J-STD-020
- Terminals: Finish-Matte Tin annealed over Copper Leadframe Solderable per MIL-STD-202, Method 208 (e3)
- Terminal Connections: See Diagram Below
- Weight: 0.008 grams (approximate)

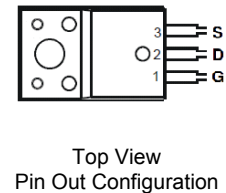
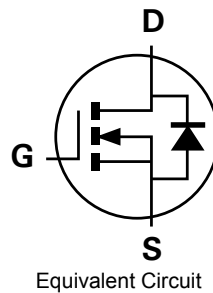
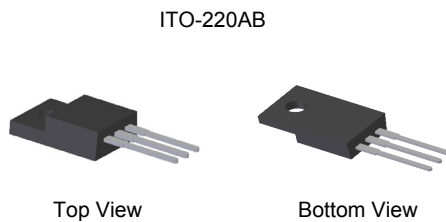
Ordering Information (Note 4)

Part Number	Case	Packaging
DMG4N65CTI	ITO220-AB	50 pieces/tube

- Notes:
1. EU Directive 2002/95/EC (RoHS) & 2011/65/EU (RoHS 2) compliant. All applicable RoHS exemptions applied.
 2. See <http://www.diodes.com> for more information about Diodes Incorporated's definitions of Halogen- and Antimony-free, "Green" and Lead-free.
 3. Halogen- and Antimony-free "Green" products are defined as those which contain <900ppm bromine, <900ppm chlorine (<1500ppm total Br + Cl) and <1000ppm antimony compounds.
 4. For packaging details, go to our website at <http://www.diodes.com>.

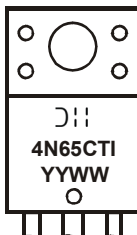
Marking Information

4N65CTI = Product Type Marking Code
 YYWW = Date Code Marking
 YY = Last two digits of year (ex: 12 = 2012)
 WW = Week (01 - 53)

Maximum Ratings @ $T_A = 25^\circ\text{C}$ unless otherwise specified

Characteristic			Symbol	Value	Unit
Drain-Source Voltage			V_{DSS}	650	V
Gate-Source Voltage			V_{GSS}	± 30	V
Continuous Drain Current (Note 5,6) $V_{GS} = 10\text{V}$	Steady State	$T_C = +25^\circ\text{C}$	I_D	4.0	A
		$T_C = +70^\circ\text{C}$		3.0	
Pulsed Drain Current (Note 7)			I_{DM}	6	A
Avalanche Current (Note 8) $V_{DD} = 100\text{V}$, $V_{GS} = 10\text{V}$, $L = 60\text{mH}$			I_{AS}	3.9	A
Repetitive avalanche energy (Note 7)			E_{AS}	456	mJ

Thermal Characteristics

Characteristic	Symbol	Max	Unit
Power Dissipation (Note 5)	P_D	8.35	W
Thermal Resistance, Junction to Ambient @ $T_A = +25^\circ\text{C}$ (Note 5)	$R_{\theta JA}$	12.36	$^\circ\text{C/W}$
Thermal Resistance, Junction to Case @ $T_A = +25^\circ\text{C}$ (Note 5)	$R_{\theta JC}$	10.69	$^\circ\text{C/W}$
Operating and Storage Temperature Range	T_J, T_{STG}	-55 to +150	$^\circ\text{C}$

Electrical Characteristics @ $T_A = 25^\circ\text{C}$ unless otherwise stated

Characteristic	Symbol	Min	Typ	Max	Unit	Test Condition
OFF CHARACTERISTICS (Note 9)						
Drain-Source Breakdown Voltage	BV_{DSS}	650	-	-	V	$V_{GS} = 0\text{V}$, $I_D = 250\mu\text{A}$
Zero Gate Voltage Drain Current $T_J = +25^\circ\text{C}$	I_{DSS}	-	-	1.0	μA	$V_{DS} = 650\text{V}$, $V_{GS} = 0\text{V}$
Gate-Source Leakage	I_{GSS}	-	-	± 100	nA	$V_{GS} = \pm 30\text{V}$, $V_{DS} = 0\text{V}$
ON CHARACTERISTICS (Note 9)						
Gate Threshold Voltage	$V_{GS(th)}$	3	-	5	V	$V_{DS} = V_{GS}$, $I_D = 250\mu\text{A}$
Static Drain-Source On-Resistance	$R_{DS(on)}$	-	2.1	3.0	Ω	$V_{GS} = 10\text{V}$, $I_D = 2\text{A}$
Forward Transfer Admittance	$ Y_{fs} $	-	3.7	-	S	$V_{DS} = 40\text{V}$, $I_D = 2\text{A}$
Diode Forward Voltage	V_{SD}	-	0.7	1.0	V	$V_{GS} = 0\text{V}$, $I_S = 1\text{A}$
DYNAMIC CHARACTERISTICS (Note 10)						
Input Capacitance	C_{iss}	-	900	-	pF	$V_{DS} = 25\text{V}$, $V_{GS} = 0\text{V}$, $f = 1.0\text{MHz}$
Output Capacitance	C_{oss}	-	50	-		
Reverse Transfer Capacitance	C_{rss}	-	1.1	-		
Gate Resistance	R_g	-	2.4	-	Ω	$V_{DS} = 0\text{V}$, $V_{GS} = 0\text{V}$, $f = 1\text{MHz}$
Total Gate Charge $V_{GS} = 10\text{V}$	Q_g	-	13.5	-	nC	$V_{GS} = 10\text{V}$, $V_{DS} = 520\text{V}$, $I_D = 4\text{A}$
Gate-Source Charge	Q_{gs}	-	2.7	-		
Gate-Drain Charge	Q_{gd}	-	3.8	-		
Turn-On Delay Time	$t_{D(on)}$	-	15.1	-	ns	$V_{GS} = 10\text{V}$, $V_{DS} = 325\text{V}$, $R_g = 25\Omega$, $I_D = 4\text{A}$
Turn-On Rise Time	t_r	-	13.8	-	ns	
Turn-Off Delay Time	$t_{D(off)}$	-	40	-	ns	
Turn-Off Fall Time	t_f	-	16	-	ns	
Body Diode Reverse Recovery Time	t_{rr}	-	515	-	ns	
Body Diode Reverse Recovery Charge	Q_{rr}	-	2330	-	nC	$dI/dt = 100\text{A}/\mu\text{s}$, $V_{DS} = 100\text{V}$, $I_F = 4\text{A}$

- Notes:
- Device mounted on an infinite heatsink
 - Drain current limited by maximum junction temperature.
 - Repetitive rating, pulse width limited by junction temperature.
 - I_{AS} and E_{AS} rating are based on low frequency and duty cycles to keep $T_J = +25^\circ\text{C}$.
 - Short duration pulse test used to minimize self-heating effect.
 - Guaranteed by design. Not subject to production testing.

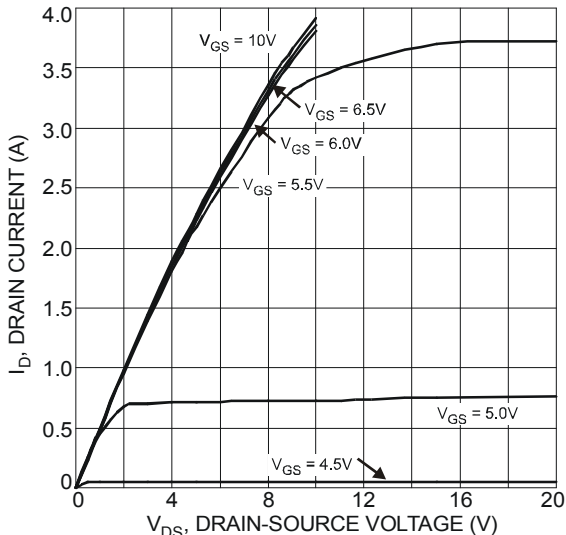

Figure 1 Typical Output Characteristic

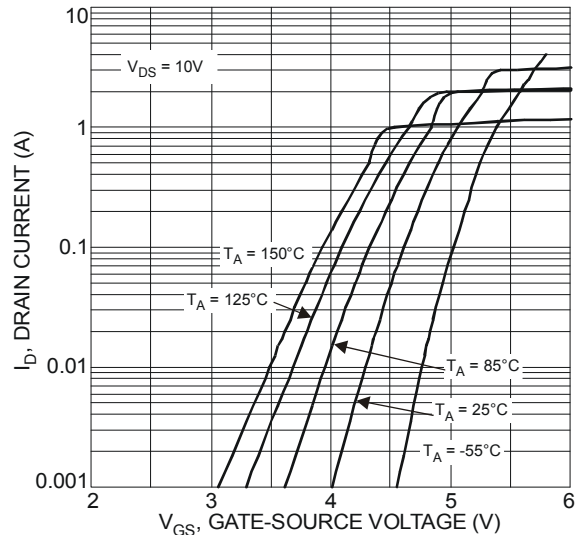

Figure 2 Typical Transfer Characteristics

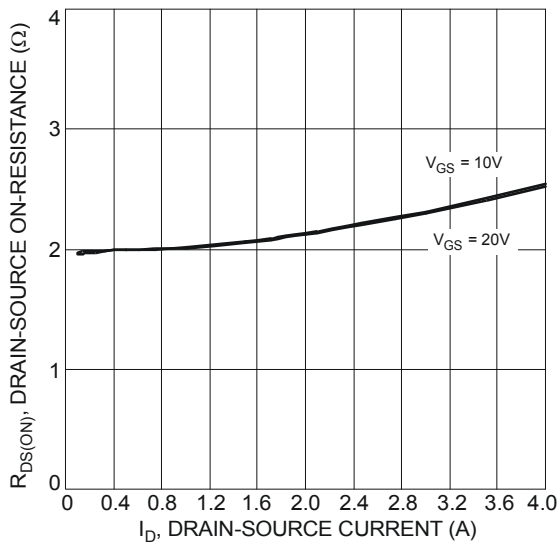

Figure 3 Typical On-Resistance vs. Drain Current and Gate Voltage

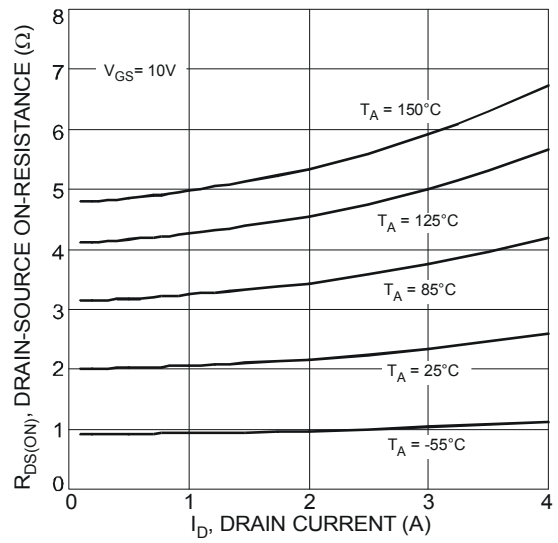

Figure 4 Typical On-Resistance vs. Drain Current and Temperature

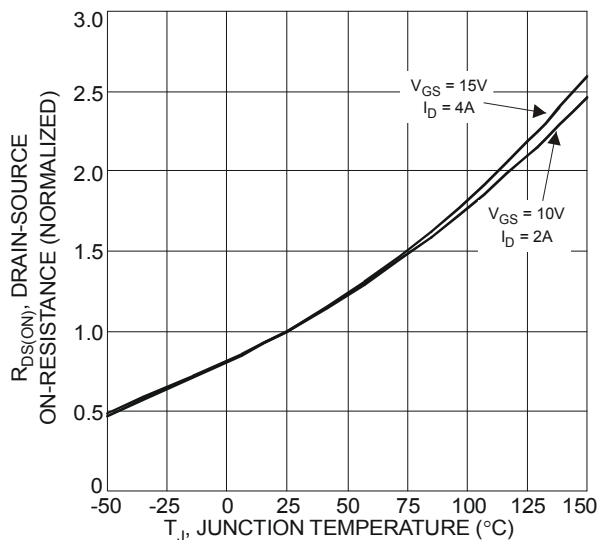

Figure 5 On-Resistance Variation with Temperature

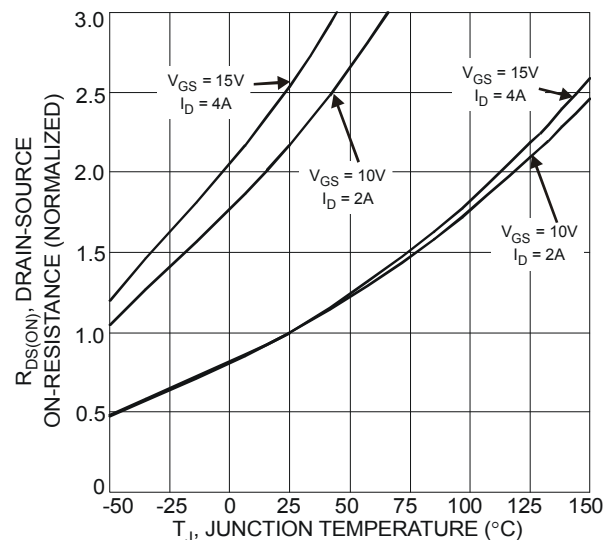

Figure 6 On-Resistance Variation with Temperature

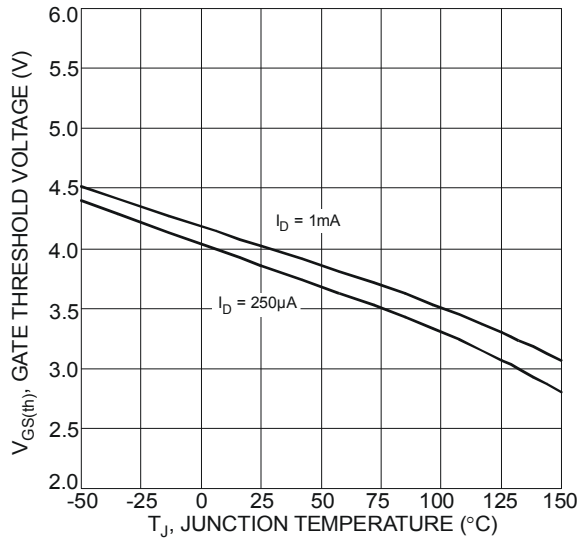

Figure 7 Gate Threshold Variation vs. Ambient Temperature

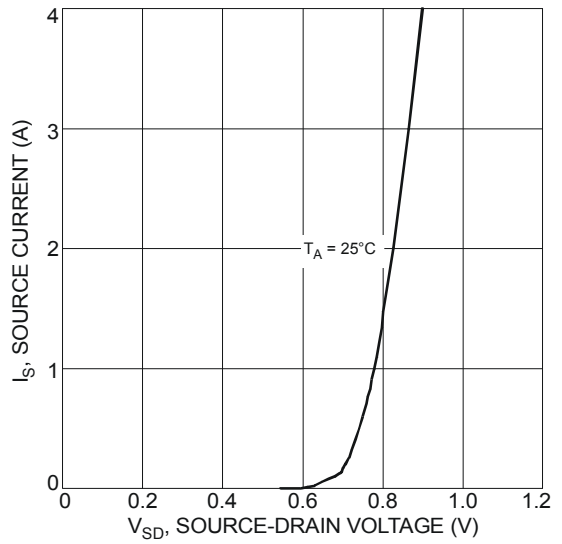

Figure 8 Diode Forward Voltage vs. Current

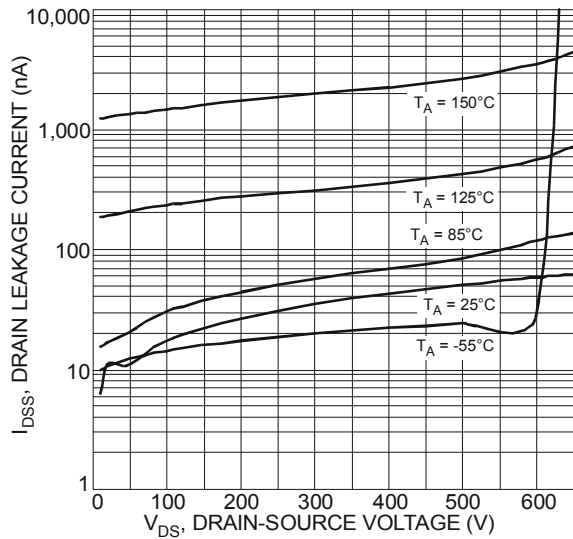
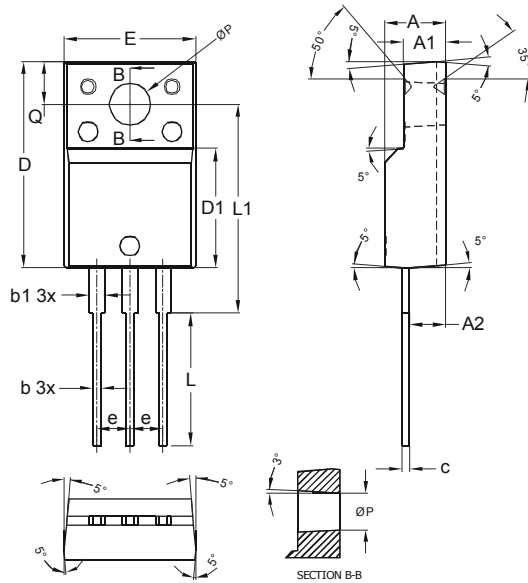

Figure 9 Typical Drain-Source Leakage Current vs. Voltage

Package Outline Dimensions

Please see AP02002 at <http://www.diodes.com/datasheets/ap02002.pdf> for latest version.



ITO-220AB			
Dim	Min	Typ	Max
A	4.50	4.70	4.90
A1	3.04	3.24	3.44
A2	2.56	2.76	2.96
b	0.50	0.60	0.75
b1	1.10	1.20	1.35
c	0.50	0.60	0.70
D	15.67	15.87	16.07
D1	8.99	9.19	9.39
e	2.54		
E	9.91	10.11	10.31
L	9.45	9.75	10.05
L1	15.80	16.00	16.20
P	2.98	3.18	3.38
Q	3.10	3.30	3.50
All Dimensions in mm			

IMPORTANT NOTICE

DIODES INCORPORATED MAKES NO WARRANTY OF ANY KIND, EXPRESS OR IMPLIED, WITH REGARDS TO THIS DOCUMENT, INCLUDING, BUT NOT LIMITED TO, THE IMPLIED WARRANTIES OF MERCHANTABILITY AND FITNESS FOR A PARTICULAR PURPOSE (AND THEIR EQUIVALENTS UNDER THE LAWS OF ANY JURISDICTION).

Diodes Incorporated and its subsidiaries reserve the right to make modifications, enhancements, improvements, corrections or other changes without further notice to this document and any product described herein. Diodes Incorporated does not assume any liability arising out of the application or use of this document or any product described herein; neither does Diodes Incorporated convey any license under its patent or trademark rights, nor the rights of others. Any Customer or user of this document or products described herein in such applications shall assume all risks of such use and will agree to hold Diodes Incorporated and all the companies whose products are represented on Diodes Incorporated website, harmless against all damages.

Diodes Incorporated does not warrant or accept any liability whatsoever in respect of any products purchased through unauthorized sales channel. Should Customers purchase or use Diodes Incorporated products for any unintended or unauthorized application, Customers shall indemnify and hold Diodes Incorporated and its representatives harmless against all claims, damages, expenses, and attorney fees arising out of, directly or indirectly, any claim of personal injury or death associated with such unintended or unauthorized application.

Products described herein may be covered by one or more United States, international or foreign patents pending. Product names and markings noted herein may also be covered by one or more United States, international or foreign trademarks.

This document is written in English but may be translated into multiple languages for reference. Only the English version of this document is the final and determinative format released by Diodes Incorporated.

LIFE SUPPORT

Diodes Incorporated products are specifically not authorized for use as critical components in life support devices or systems without the express written approval of the Chief Executive Officer of Diodes Incorporated. As used herein:

A. Life support devices or systems are devices or systems which:

1. are intended to implant into the body, or
2. support or sustain life and whose failure to perform when properly used in accordance with instructions for use provided in the labeling can be reasonably expected to result in significant injury to the user.

B. A critical component is any component in a life support device or system whose failure to perform can be reasonably expected to cause the failure of the life support device or to affect its safety or effectiveness.

Customers represent that they have all necessary expertise in the safety and regulatory ramifications of their life support devices or systems, and acknowledge and agree that they are solely responsible for all legal, regulatory and safety-related requirements concerning their products and any use of Diodes Incorporated products in such safety-critical, life support devices or systems, notwithstanding any devices- or systems-related information or support that may be provided by Diodes Incorporated. Further, Customers must fully indemnify Diodes Incorporated and its representatives against any damages arising out of the use of Diodes Incorporated products in such safety-critical, life support devices or systems.

Copyright © 2012, Diodes Incorporated

www.diodes.com